

Modernizing the Power Grid and Understanding Potential Impacts from Solar Weather

Ben Kroposki, PhD, PE, FIEEE
Director – Power Systems Engineering Center
National Renewable Energy Laboratory

2019 Space Weather Workshop

The Grid of the Past

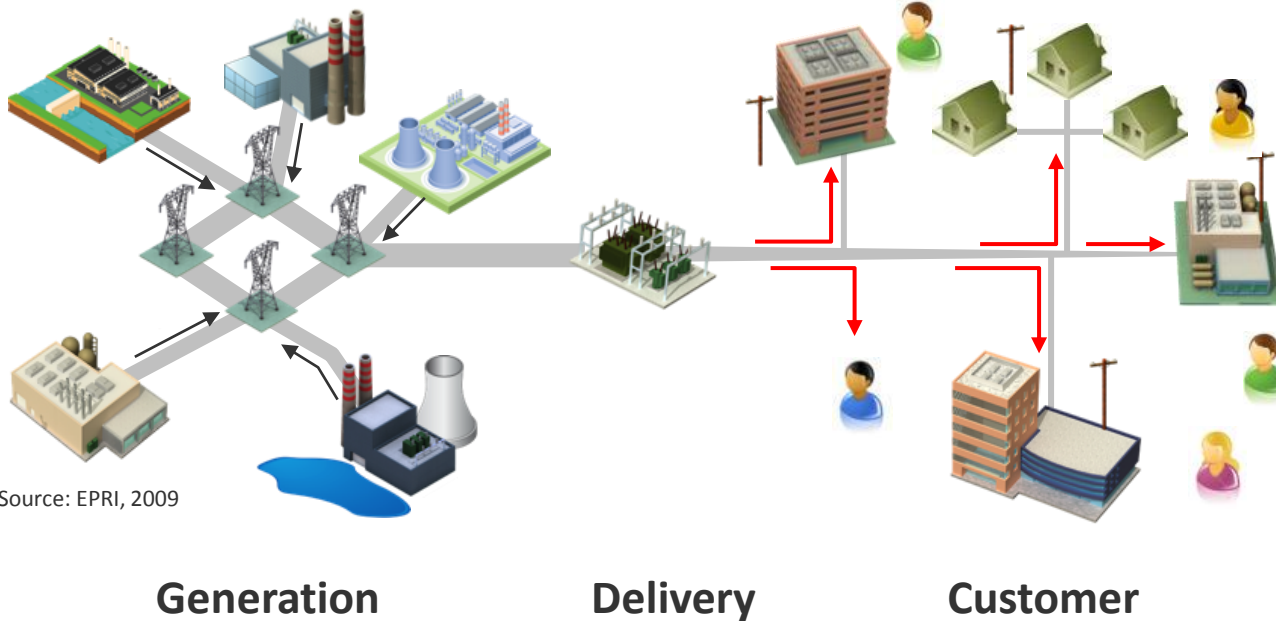

- One-way Power Flow to Customers
- Based on large-scale synchronous generators
- Lots of iron, copper, and aluminum
- Central controls
- Dispatchable generation follows demand
- Passive Customer

The Grid of the Future

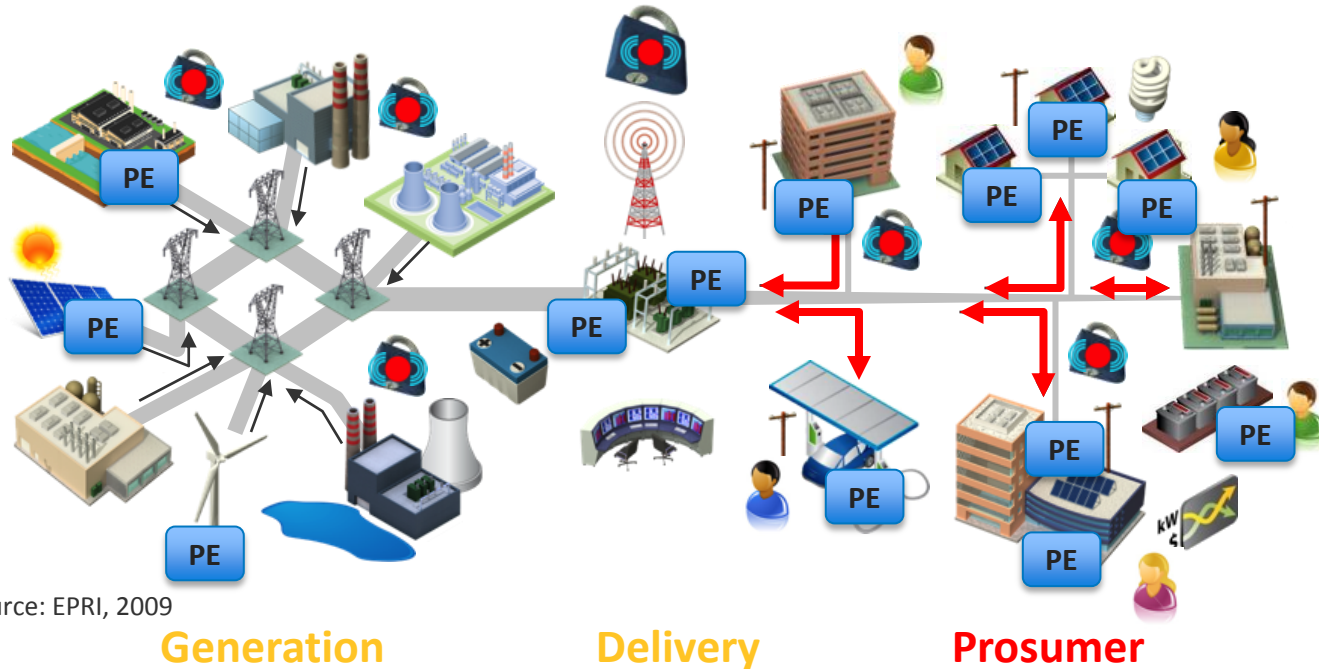

- Two-way Power Flow to and from Customers
- More power electronics
- More communications, data, and information
- Need for cybersecurity and interoperability
- Variable generation is weather dependent

Source: EPRI, 2009

PE Power Electronics – Wind, Solar, EV, VSD, Lighting, HVDC, Volt/var controllers

Grid Modernization Vision



*The future grid provides a critical platform for U.S. prosperity, competitiveness, and innovation in a global clean energy economy. It must deliver **reliable, affordable, and clean electricity** to consumers where they want it, when they want it, how they want it.*

Enhance the Security of the Nation

- Extreme weather
- Cyber threats
- Physical attacks
- Natural disasters
- Fuel and supply diversity
- Aging infrastructure

Sustain Economic Growth and Innovation

- New energy products and services
- Efficient markets
- Reduce barriers for new technologies
- Clean energy jobs

Achieve Public Policy Objectives

- 80% clean electricity by 2035
- State RPS and EEPS mandates
- Access to reliable, affordable electricity
- Climate adaptation and resilience

Key Future Grid Attributes

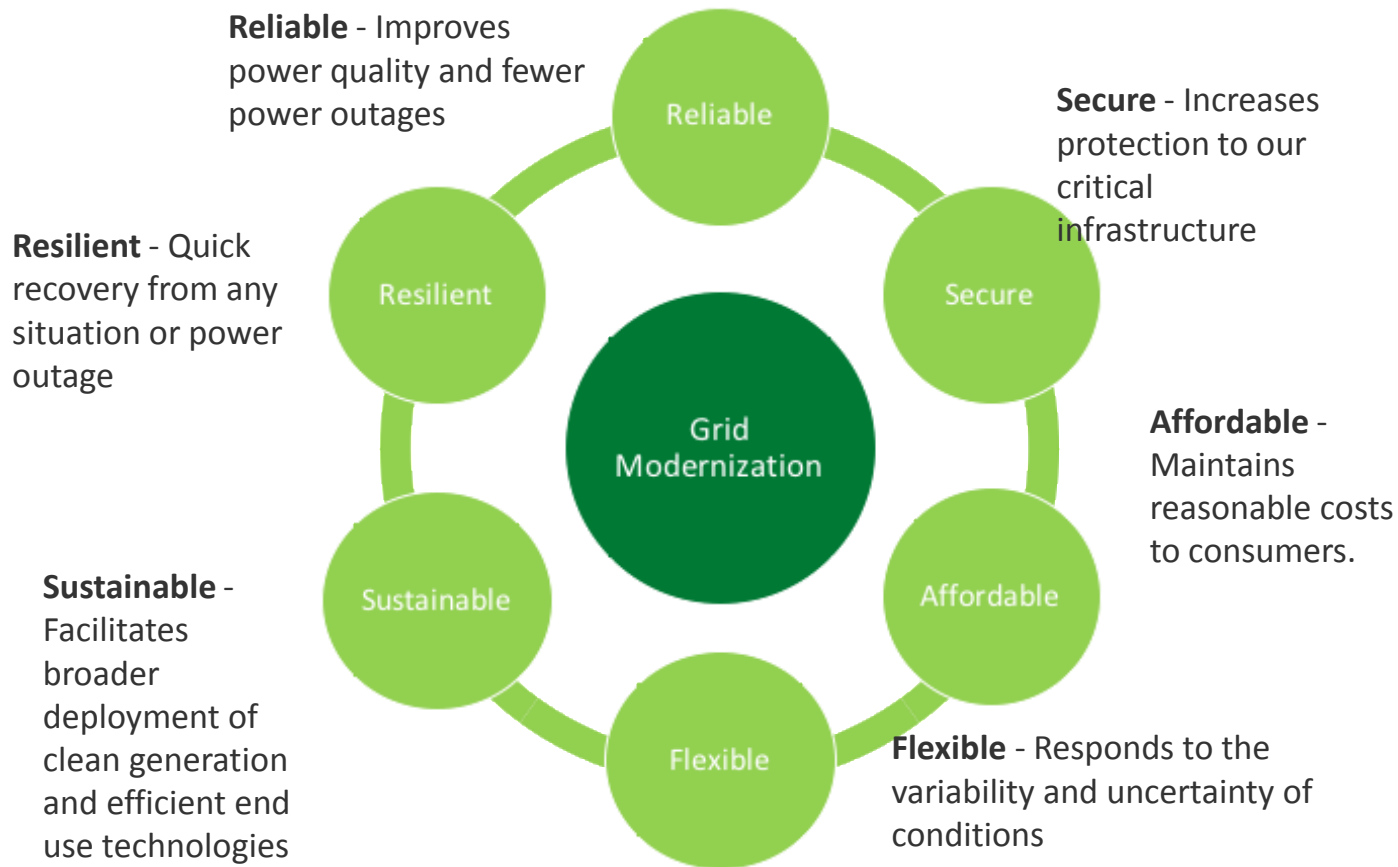

DOE Grid Modernization Initiative

An aggressive five-year grid modernization strategy that includes

- Alignment of the existing base activities among DOE Offices
- An integrated Multi-Year Program Plan (MYPP)
- New activities to fill major gaps in existing base
- Development of a laboratory consortium with core scientific abilities and regional outreach

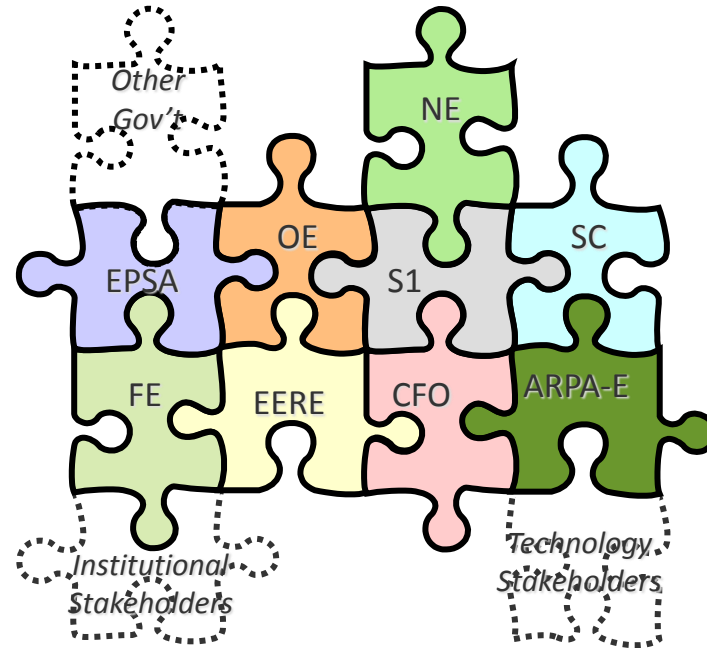

GMLC - Foundational R&D Activities



Devices and Integrated Systems

Characterization and testing of energy technologies for providing grid services to improve system affordability, reliability and sustainability

Expected Outcomes

- Develop new grid interface devices to increase ability to provide grid services and utilization
- Coordinate and support the development of interconnection and interoperability test procedures for provision of grid services
- Validate secure and reliability grid operation with high levels of variable generation at multiple scales

Federal Role

- Common approach across labs and industry test-beds for effective validation of emerging technologies
- Develop common interoperability and interconnection standards and test procedures for industry / vendor community

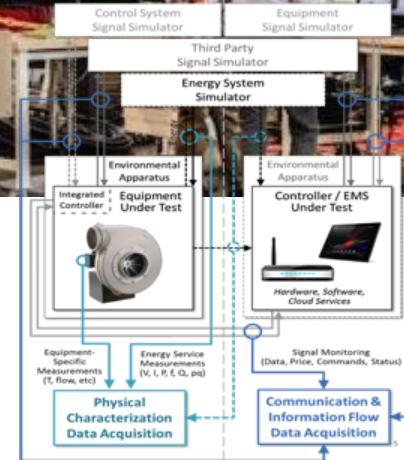

Advanced real-time control technologies to enhance the reliability and asset utilization of transmission and distribution systems

Expected Outcomes

- Deliver an architecture, algorithms, and control frameworks for a clean, resilient and secure grid
- Advanced operations software platform for predictive operations & real-time adaptive control
- New power flow control device hardware and concepts
- Advance fundamental knowledge for new control paradigms

Federal Role

- Convening authority to shape vision of advanced grid architecture
- Advance fundamental knowledge for new control paradigms for emerging grid to support industry transformation
- Deliver computational science, materials science & mathematics from National Laboratories to develop integrated faster-than-real-time software platforms and power electronics control schemes

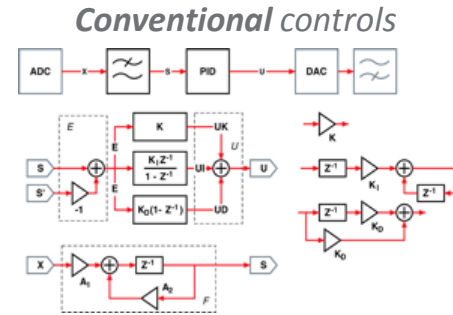

Distributed controls



Drive next generation of tools to accurately perform cost-benefit trade-offs and improve reliability of design for deployment new smart grid and renewables

Expected Outcomes

- Incorporate uncertainty and system dynamics into planning tools to accurately capture effects of renewable generation
- Computational tools, methods and libraries that enable 1000x improvements in performance for analysis and design
- Couple grid transmission, distribution, and communications models to understand cross-domain effects

Federal Role

- Apply National Lab advanced computing expertise and capabilities to develop new tools for stakeholder utilization

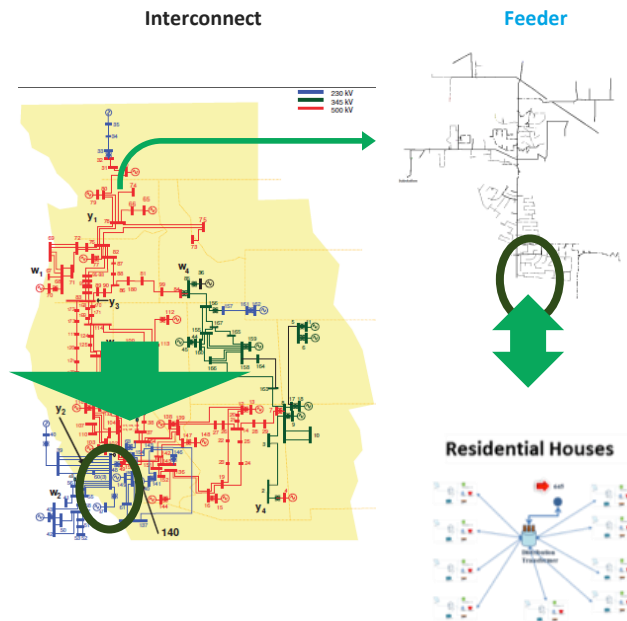

Security and Resilience

Providing a pathway to comprehensive multi-scale security and resilience for the nation's power grid

Expected Outcomes

- Holistic grid security and resilience, from devices to micro-grids to systems
- Inherent security designed into components and systems, not security as an afterthought
- Security and resilience addressed throughout system lifecycle and covering the spectrum of legacy and emerging technologies

Federal Role

- Lead and establish security and resilience research programs to develop technology solutions and best practice guidance
- Improve adoption of security and resiliency practices, and provide technology-neutral guidance
- Inform stakeholders of emerging threats and help address threats appropriate for government response

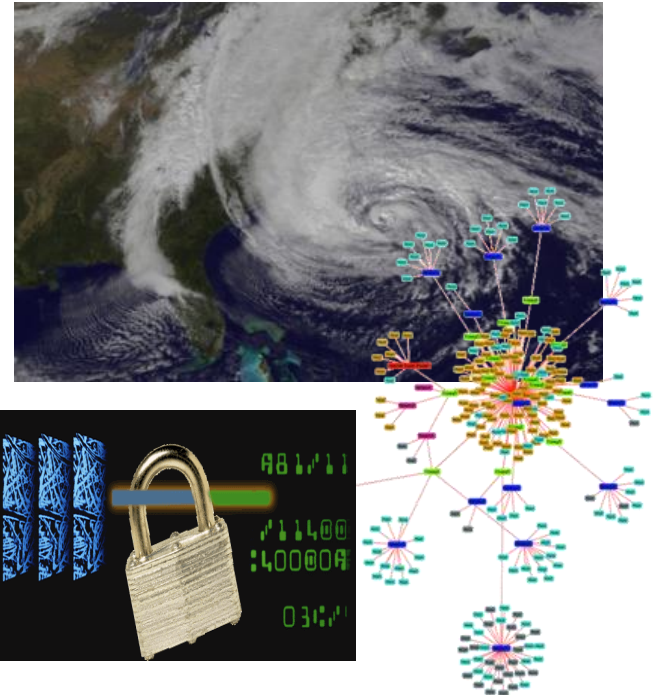

Institutional Support

Enable regulators and utility/grid operators to make more informed decisions and reduce risks on key issues that influence the future of the electric grid/power sector

Expected Outcomes

- Accelerated state & federal policy innovation due to enhanced State and Regional technical assistance
- States adopt changes to their regulatory model that better align utility interests with grid modernization and/or clean energy policy goals
- Methods for valuation of DER technologies and services are defined and clearly understood by stakeholders to enable informed decisions on grid investments and operations

Federal Role

- Provide independent, unbiased technical assistance (e.g., information and analysis tools) that address key grid-related policy, regulatory, and market issues
- Create an over-arching stream of grid-related “institutional” analysis, workshops, and dialogues to raise awareness of the need for grid modernization





Solar Weather

Solar Weather especially coronal mass ejections can significantly impact the power grid

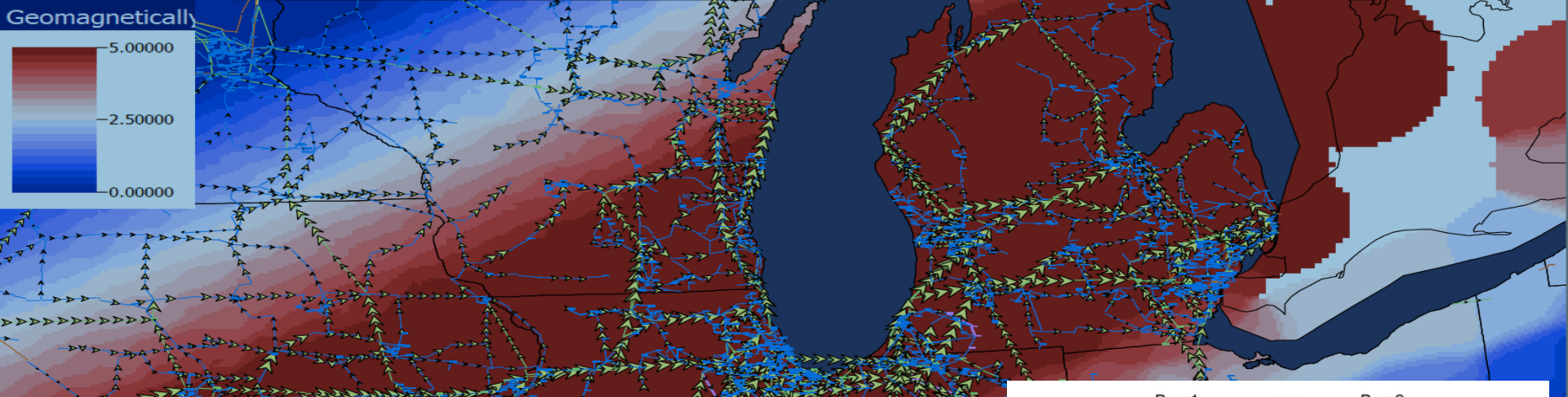
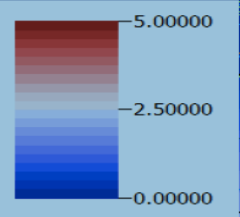

Geomagnetic Disturbances

- Space weather can impact the operations of electrical power systems since it can cause electro-magnetic reactions in the electrical grid and its components.
- Geomagnetic disturbances (GMD) occur when particles discharged from the sun during solar storms interact with the earth's magnetic field. Power systems are vulnerable to geospatial variation in dc voltage caused by GMD.
- Geomagnetically induced currents (GIC) flow through circuits formed by the earth, a grounded transformer, a high-voltage transmission line, and a grounded transformer at the other end of the transmission line. The impact of the GICs on the operation of the power grid is primarily due to the half-cycle saturation they cause in the transformers and large-scale blackout due to voltage collapse.

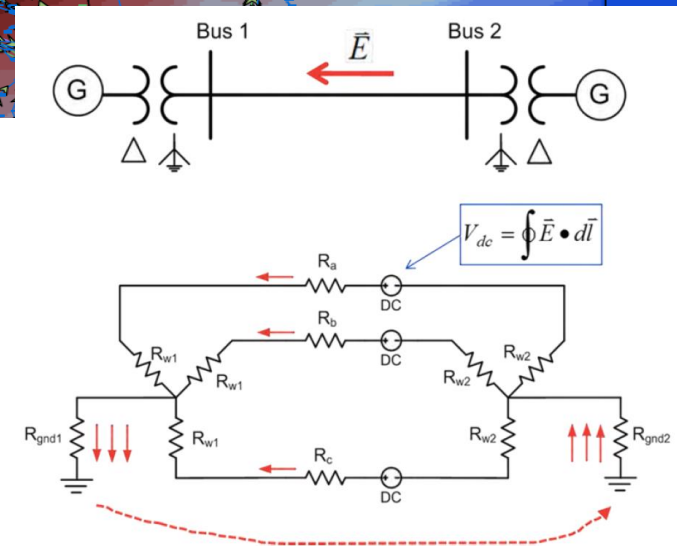

GMD – March 1989

- a) Earth's Normal Magnetosphere
- b) Earth's substorm Magnetosphere
- c) The geomagnetically induced current in transmission lines

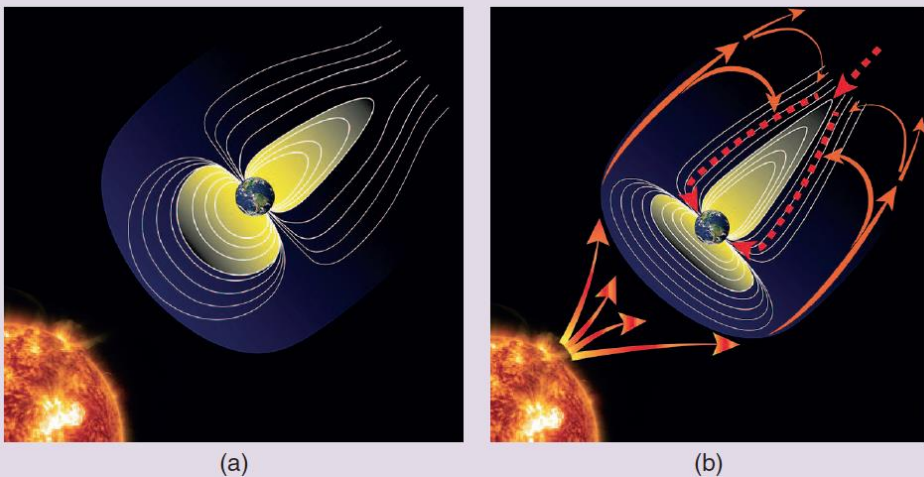

(a)

(b)

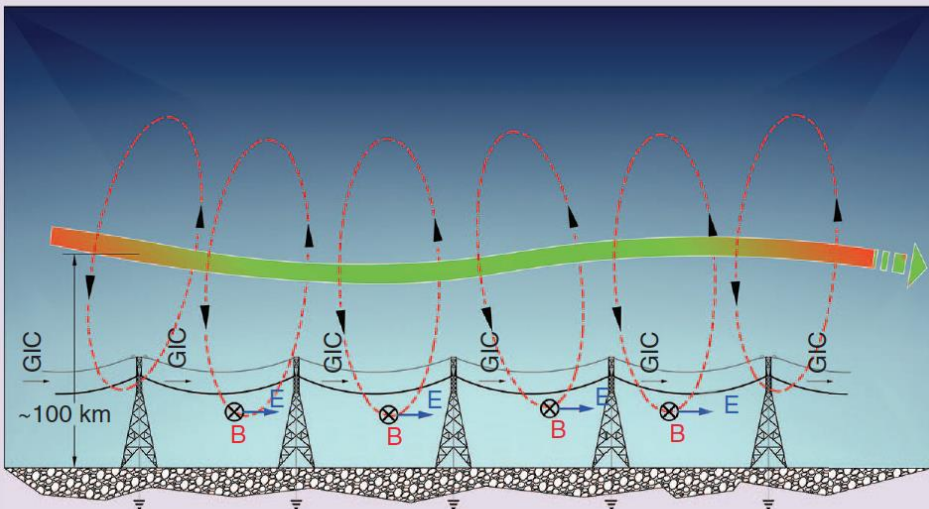

(c)

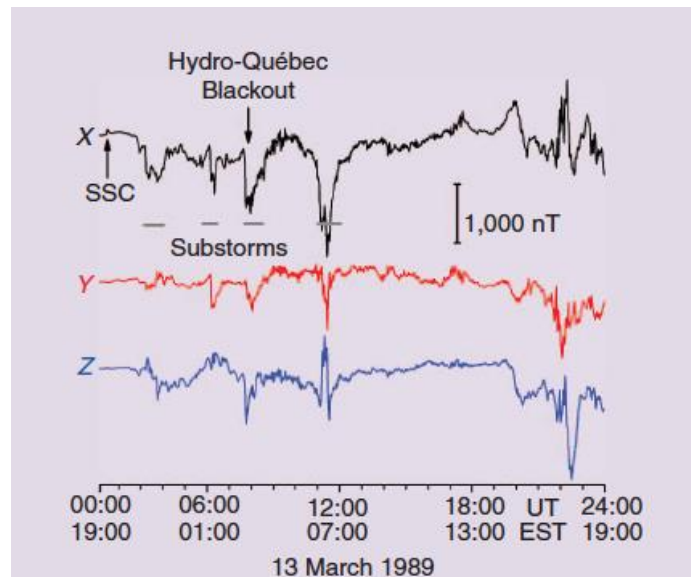

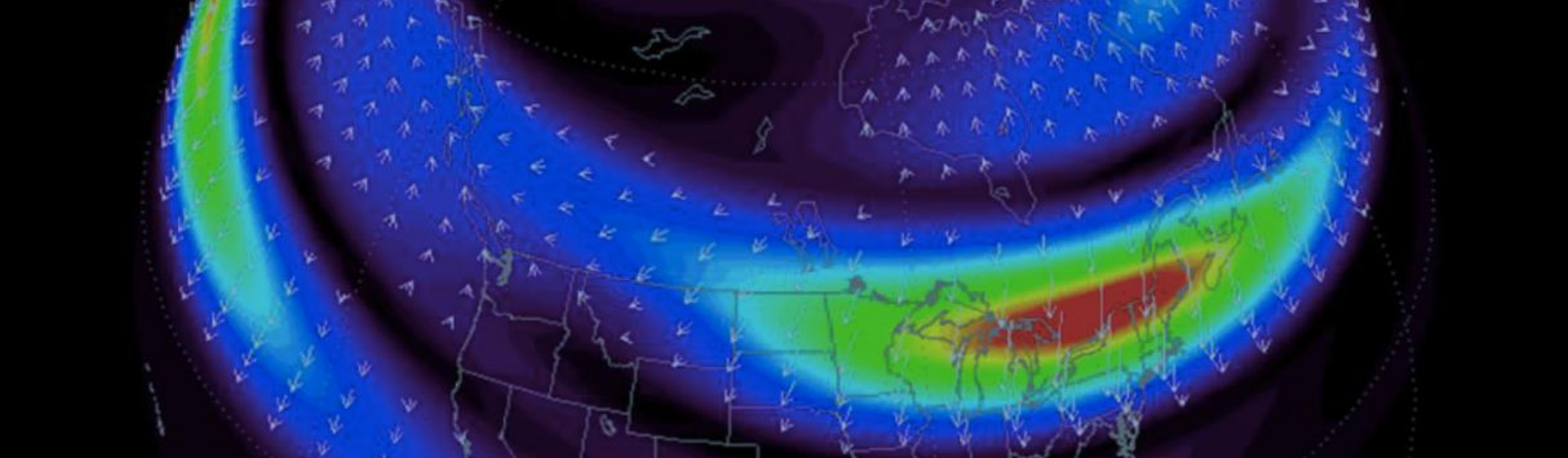

Past GMD Events

- 1859 and 1921 – Very large storms prior to large-scale transmission systems
- March 1989 – Quebec – Caused large-scale Blackout taking 9 hours to restore
- May 1998 – Maine, July 2000 – Oregon, October 2003 – Oregon – smaller storms that did not cause issues
- July 2012 – Near miss – likely to have been the largest GMD in the last 150 years

FERC Orders are in place for Operations Standards and Planning for GMD

Reference Material

DOE Grid Modernization Initiative

<https://www.energy.gov/grid-modernization-initiative>

“A Colorful Blackout”, S. Guillon, P. Toner, L. Gibson, and D. Boteler,
IEEE Power and Energy Magazine, Nov/Dec 2016

PowerWorld Simulator GIC, T. Overbye, 2016

https://www.powerworld.com/files/ClientConference2016_10_OverbyeGMD.pdf

PSERC Tutorial: High Altitude Electromagnetic Pulse (HEMP) Impacts on the Grid, T. Overbye, 2016

https://www.powerworld.com/files/Overbye_EMPb_June2016.pdf

GMD Vulnerability Assessment, T. Overbye, 2016

<https://www.ferc.gov/CalendarFiles/20160301081949-Overbye,%20University%20of%20Illinois.pdf>

Geomagnetically Induced Currents and their effect on power systems, T. Hutchins, 2012

https://www.ideals.illinois.edu/bitstream/handle/2142/30963/Hutchins_Trevor.pdf?sequence=1

GMD Monitoring and Mitigation for the Electric Grid, J. Ostrich, 2018

https://cpaess.ucar.edu/sites/default/files/documents/sww-2018-presentations/Ostrich_John_04.pdf

Examination of NERC GMD Standards and Validation of Ground Models and Geo-Electric Fields, J. Kappenman and W. Radsky, 2017,

http://www.firstempcommission.org/uploads/1/1/9/5/119571849/emp_2017_staff_paper_-_gmd_standards_final.pdf

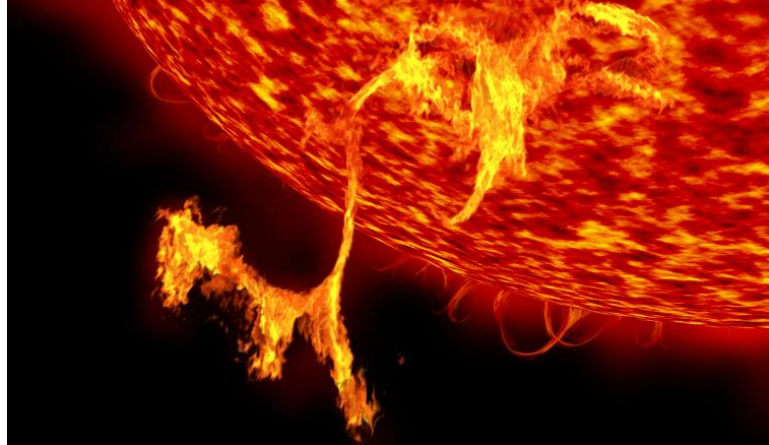

Thank you

www.nrel.gov

NREL is a national laboratory of the U.S. Department of Energy, Office of Energy Efficiency and Renewable Energy, operated by the Alliance for Sustainable Energy, LLC.

